



MB

Größe 22-28

Bauliche Merkmale :

- Stahlgehäuse pulverbeschichtet
- Laufrad verzinkt
- mit Motorkonsole (Motor B3)
- Mit 1-Phasen und 3-Phasen Motoren lieferbar
- Isolierklasse F
- Schutzart IP-55
- Max. Mediumtemperatur: 130°C

Einsatzbereiche :

- Zur Kühlung von Maschinen, Motoren, Bauteilen, usw.
- Transport von sauberer Luft
- **Keine Verwendung bei ATEX !!!**

Typ MB

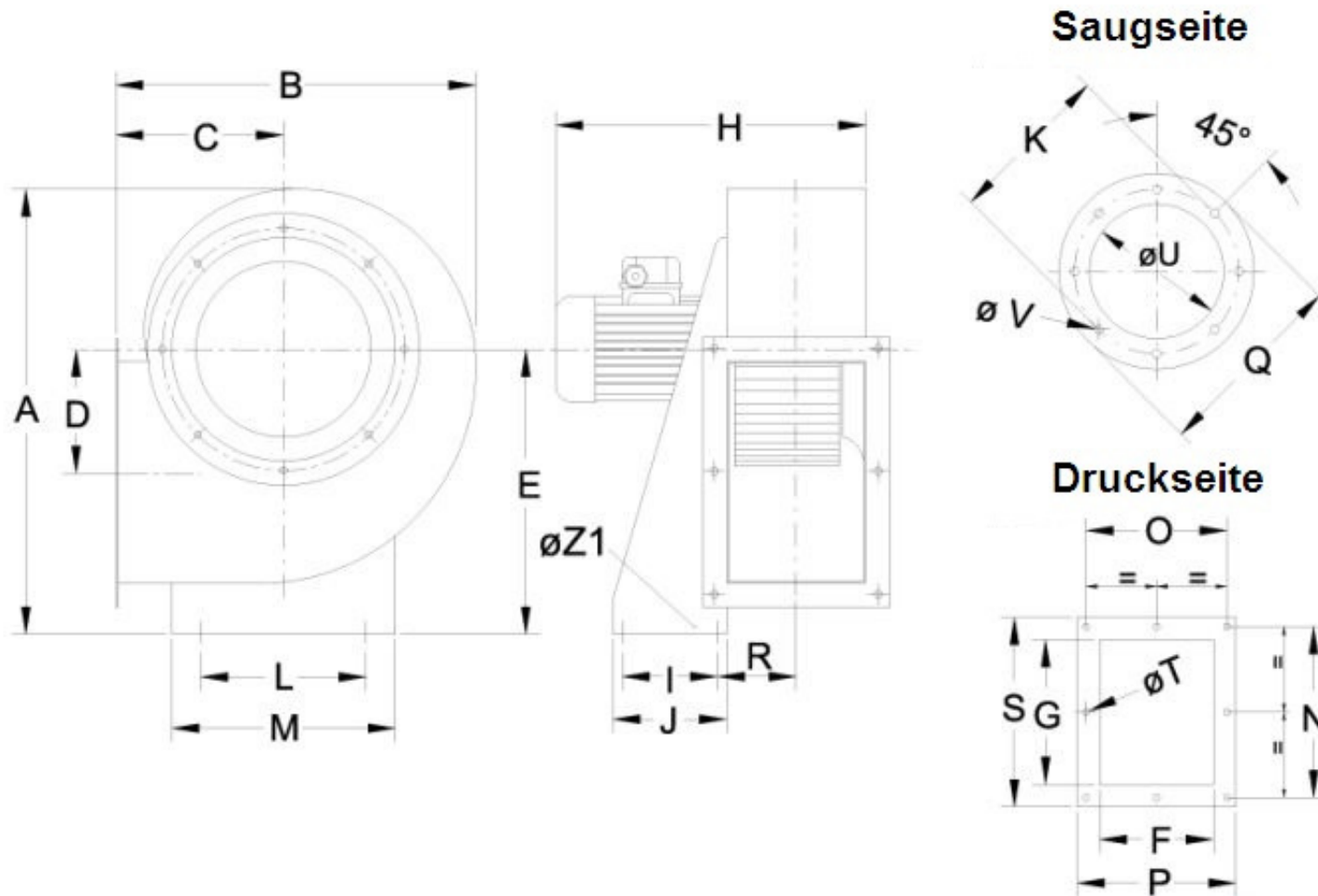

Typ MB

Typ	A	B	C	D	E	F	G	H	I	J	K	L	M	N	O	P	Q	R	S	T Ø	U Ø	V Ø	Z Ø
MB 22/9 T2 1,1 kW	452	386	181	134	280	140	216	381	50	110	256	220	290	256	280	204	280	100	282	9	180	9	11
MB 22/9 T2 2,2 kW	452	386	181	134	280	140	216	429	50	110	256	220	290	256	280	204	280	100	282	9	180	9	11
MB 22/9 T4 0,37 kW	452	386	181	134	280	140	216	381	50	110	256	220	290	256	280	204	280	100	282	9	180	9	11
MB 25/10 T2 2,2 kW	501	425	197	144	310	165	250	447	74	134	282	228	315	290	205	229	306	113	314	9	203	9	13
MB 25/10 T2 3 kW	501	425	197	144	310	165	250	477	74	134	282	228	315	290	205	229	306	113	314	9	203	9	13
MB 25/10 T4 0,75 kW	501	425	197	144	310	165	250	429	74	134	282	228	315	290	205	229	306	113	314	9	203	9	13
MB 28/11 T2 4 kW	553	471	216	152	340	180	300	515	95	144	320	245	348	340	220	244	348	120	364	9	228	9	13
MB 28/11 T4 1,1 kW	553	471	216	152	340	180	300	493	95	144	320	245	348	340	220	244	348	120	364	9	228	9	13

3-Phasen Motoren	Typ	Volumenstrom max. (m ³ /h)	Nenn Drehzahl (U/min)	Motornennleistung (kW)	Nennstrom 230V (A)	Nennstrom 400V (A)	Gewicht (kg)	Schallpegel dB (A)
	MB 22/9 T2 1,1 kW	1570	2800	1,1	4,42	2,55	24	70
	MB 22/9 T2 2,2 kW	2750	2800	2,2	8,61	4,98	30	74
	MB 22/9 T4 0,37 kW	1930	1400	0,37	1,65	0,95	21	60
	MB 25/10 T2 2,2 kW	2550	2800	2,2	8,61	4,98	32	77
	MB 25/10 T2 3 kW	3700	2870	3	11,1	6,4	38	78
	MB 25/10 T4 0,75 kW	2530	1400	0,75	3,48	2,01	26	64
	MB 28/11 T2 4 kW	3800	2890	4	14,2	8,2	46	81
	MB 28/11 T4 1,1 kW	3485	1430	1,1	4,74	2,75	32	68

Kennlinie MB 22/9 T2 1,1 kW

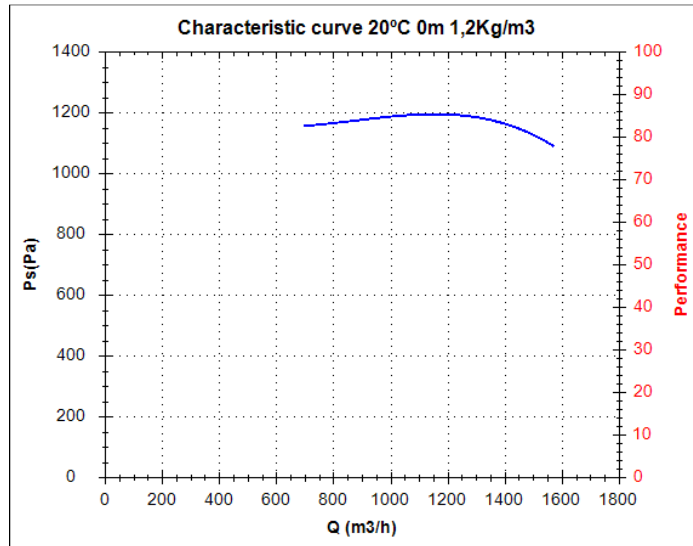

Kennlinie MB 22/9 T2 2,2 kW

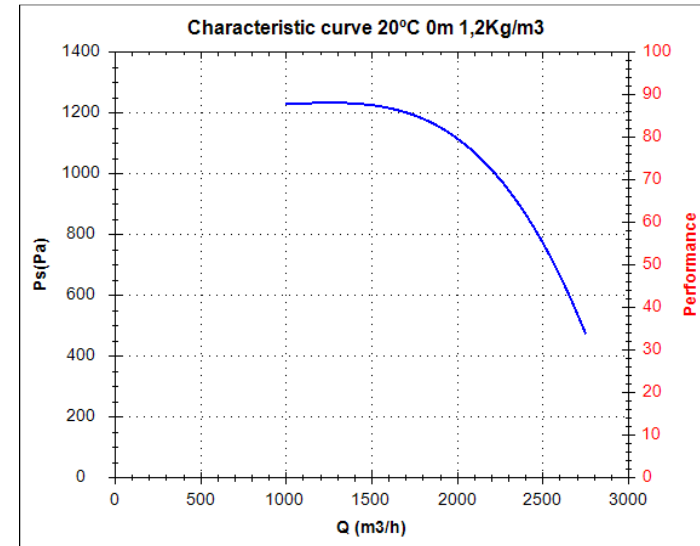

Kennlinie MB 22/9 T4 0,37 kW

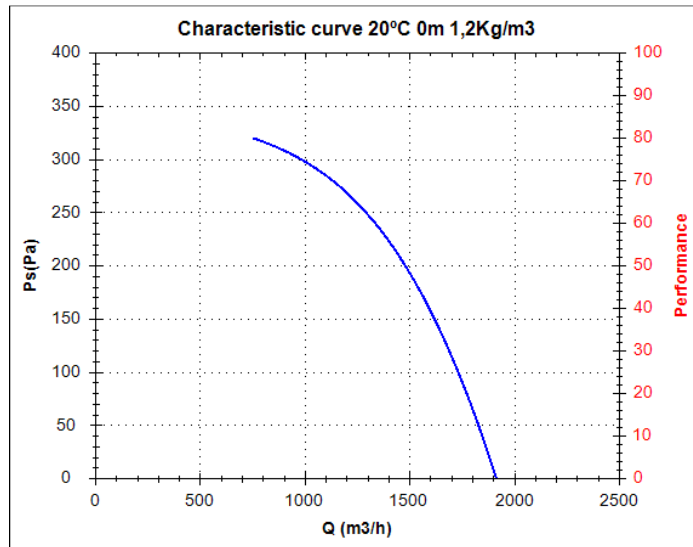

Kennlinie MB 25/10 T2 2,2 kW

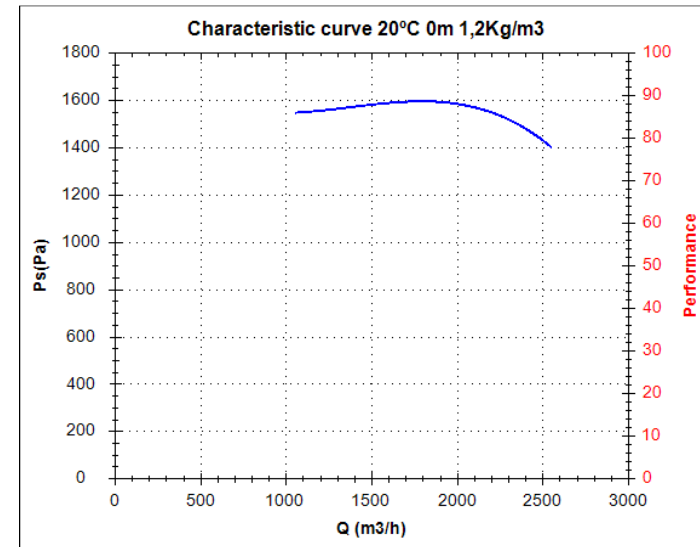

Kennlinie MB 25/10 T2 3 kW

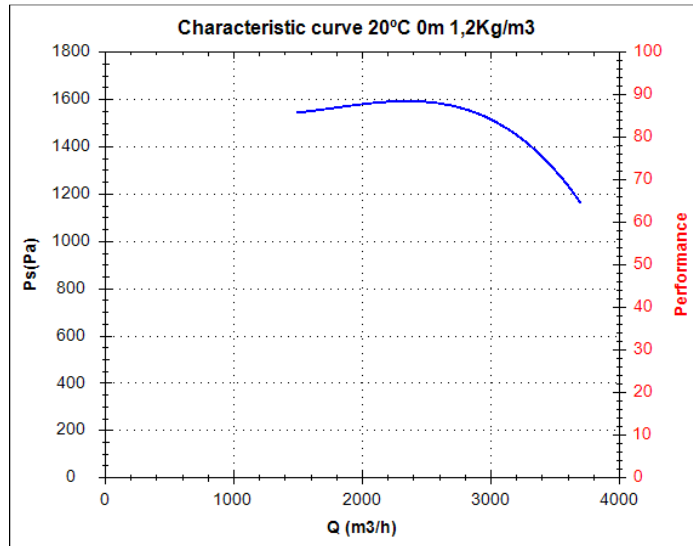

Kennlinie MB 25/10 T4 0,75 kW

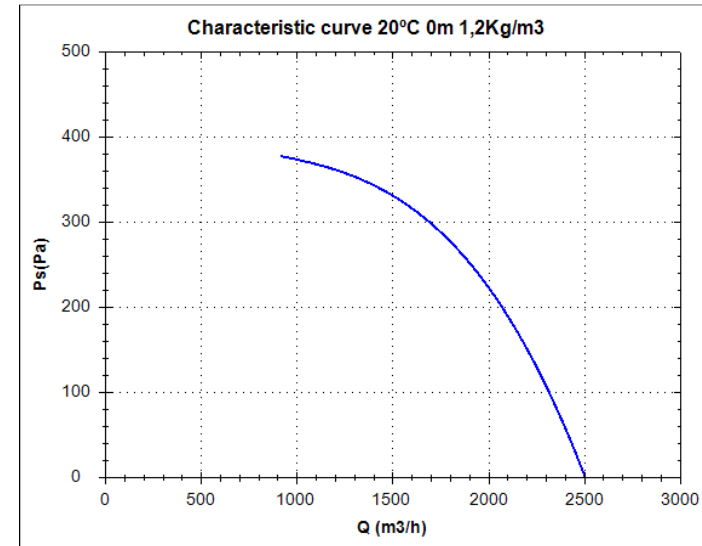

Kennlinie MB 28/11 T2 4 kW

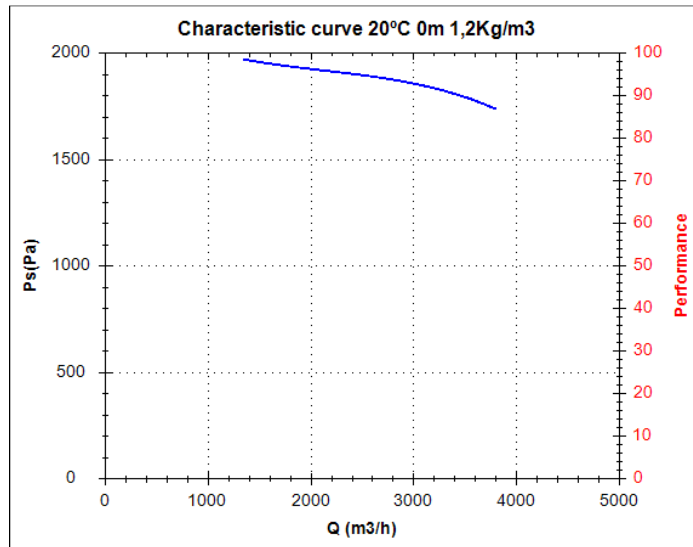

Kennlinie MB 28/11 T4 1,1 kW

